

# ANOUR

## I - MODEL CORDLESS

### Installation manual

Please, read our instructions before installing and using the product. If you have any problems with the electrical installation, contact an electrician. Be sure to turn off the power before you start the installation. In some countries, all electrical installation must be carried out by professional electricians only. For further information, contact the relevant authorities.

Our products are for indoor use only. Check on a regular basis that the cord and other parts are not damaged. In this case, the product must not be used. Save these instructions for future use.

We use LED as a light source for our products. For replacement of LED contact Anour. The product should not be dismantled as it may get damaged. The product should not come into direct contact with water. Trailing edge dimming is not available for our product. We do not supply power cable from outlet to the power supply.

Our products are marked with the symbol of the crossed out wheelie bin. That means that the product should not be disposed of with other household waste. Our products must be recycled in accordance with local environmental regulations for the disposal of waste. In complying with this you will help to minimize any adverse effect on human and environmental health.

If you have any questions please contact Anour.  
contact@anour.dk (2021)

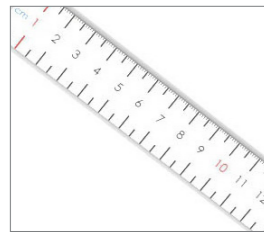
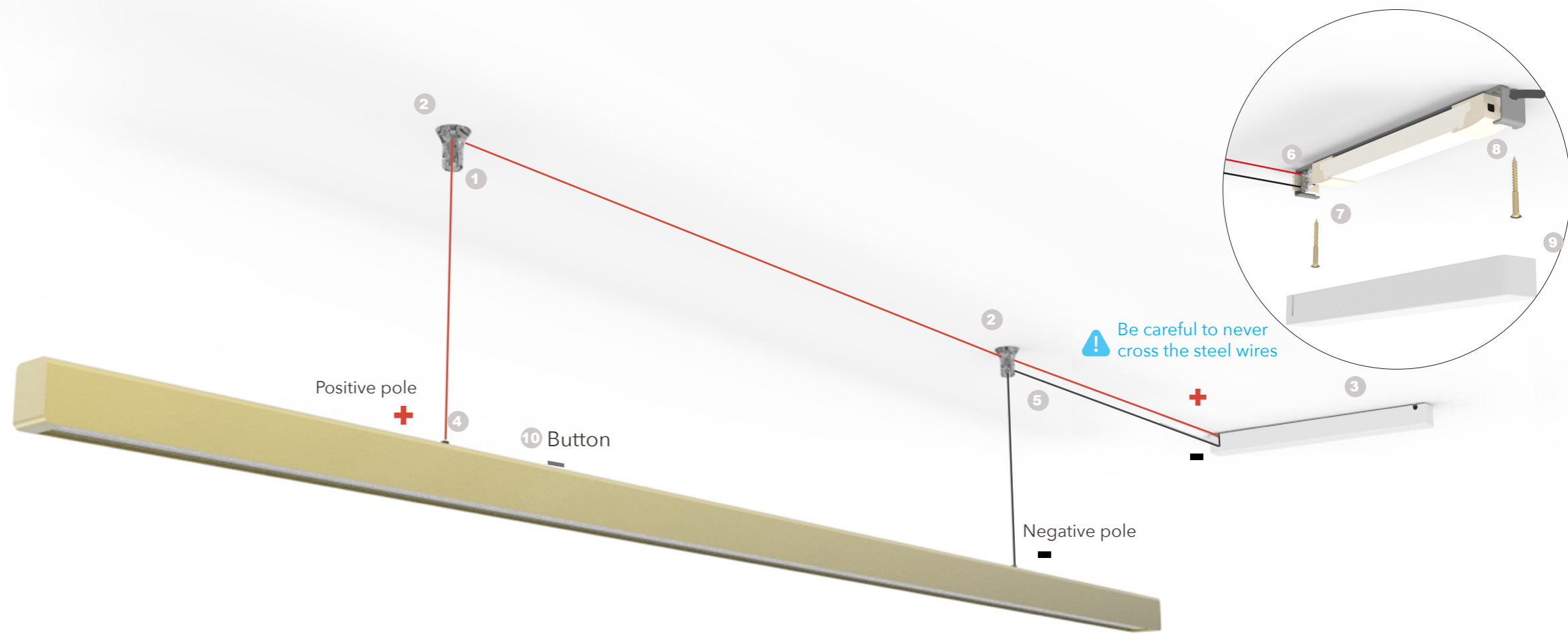

**1.** Measure distance between the suspension points. See below.



**2.** Drill holes and fasten the plastic ceiling components.

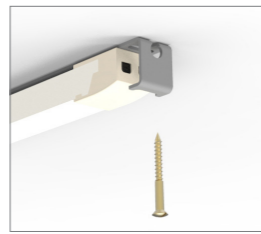

**3.** Position the driver box (see diagram below), drill holes and fasten it.

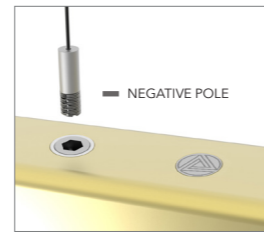

**4.** Attach the wires to the nipples and tightly fasten the wires to the lamp.

⚠ The negative pole is the suspension point closest to the logo.

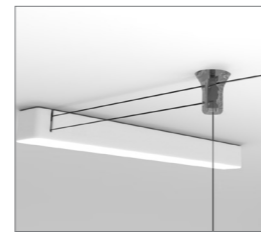

**5.** Insert the steel wires in the 2 plastic ceiling components. Assure that the wires are aligned.

⚠ Be careful to never cross the steel wires.

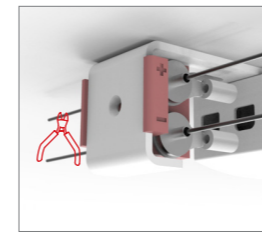

**6.** Insert the + wire in the + terminal and the - wire in the - terminal.

You can change the position of the poles by repositioning the wire grippers. ↻

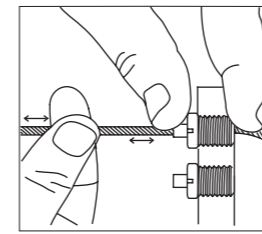

**7.** Adjust the height of the lamp by pressing the wire gripper and, **cut the excess wire**, as shown.

We recommend to hang the light with a distance of +/- 60cm above a dining table. For kitchen table tops, we recommend +/- 70 - 80cm.

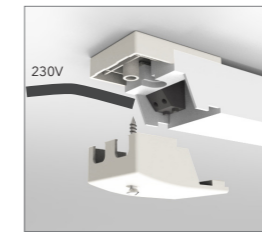

**8.** Connect the power cable to the (PRI) terminals on the primary side of the power supply and then, fasten the screw of the safety cap.

We do not supply power cable from outlet to power supply.

⚠ Should be performed according to safety regulations.

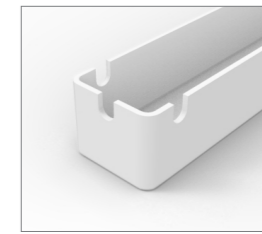

**9.** Cut out one input for the primary power cable (3 options shown) in the white plastic lid and then attach the lid to the power supply (magnetic closure).

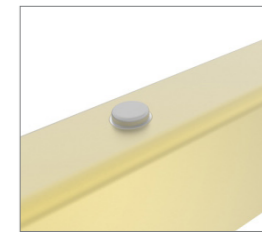

**10.** On / Off / Dimming.

- Quick tap on the button on the lamp = On/Off.
- Hold finger on the button = brighten or dim.
- Double tap: for max or min brightness

### DIMENSIONS

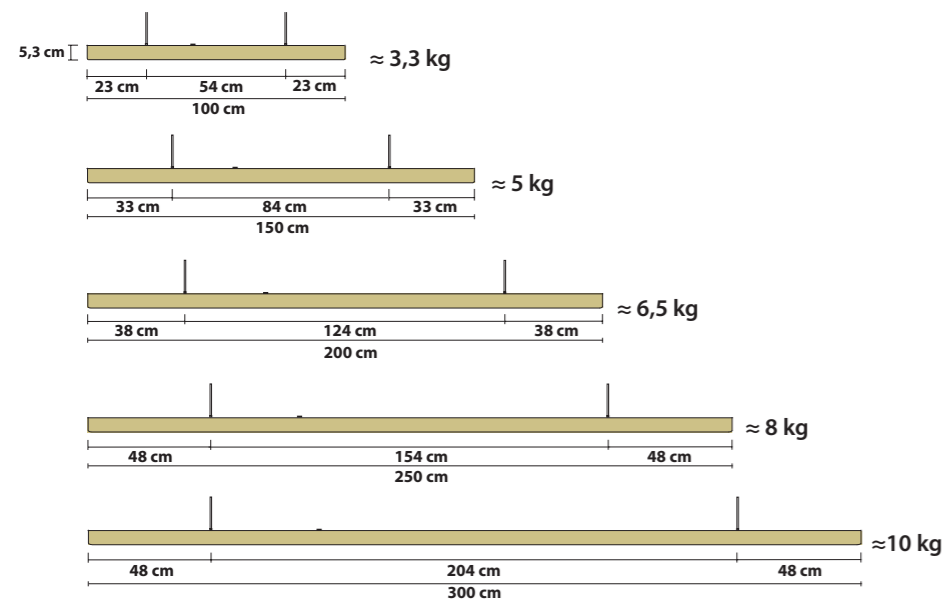

### DRIVER BOX POSITION OPTIONS: (TOP VIEW DIAGRAM)

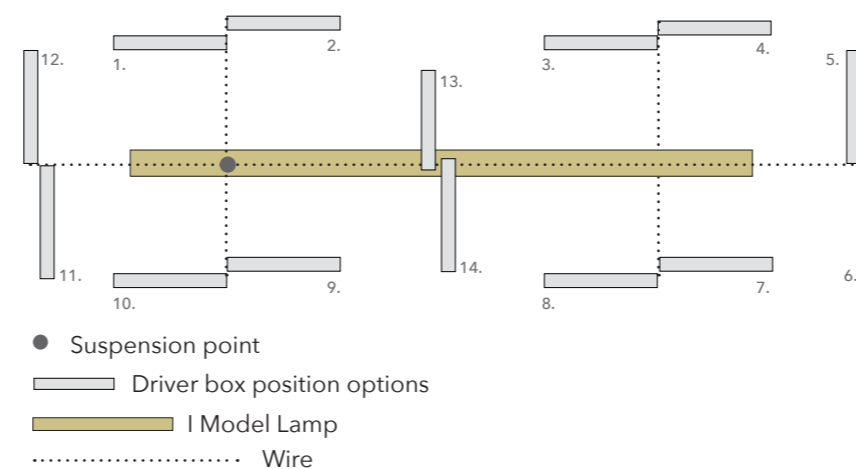

### PARTS: (INCLUDED IN THE PACKAGE)

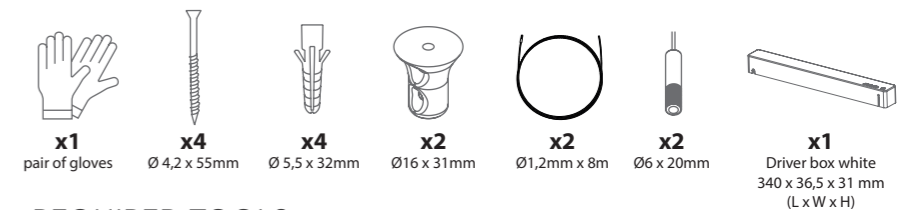

### REQUIRED TOOLS: (NOT INCLUDED)

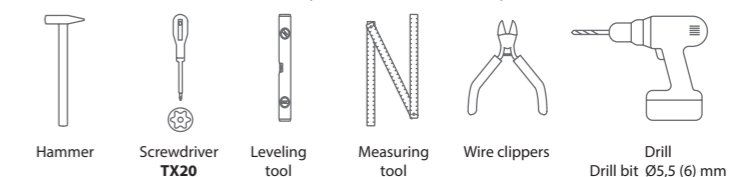

# WIRING INSTALATION MANUAL - luminary length up to **2,5 meter**

**Check your order first, as you cannot combine multiple solutions.**

If you have any problems with the electrical installation, contact an electrician. Be sure to turn off the power before you start the installation. In some countries, all electrical installation must be carried out by professional electricians only. For further information, contact the relevant authorities.

Trailing edge dimming is not available.

We do not supply power cable from outlet to power supply.

## 1. DIAGRAM STANDARD WITH TOUCH DIMMER BUTTON ON THE LAMP



## 2. DIAGRAM DALI

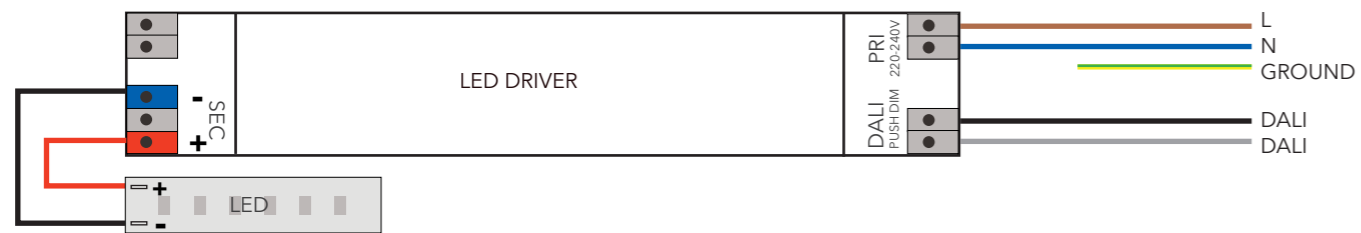

## 3. DIAGRAM PUSH DIM

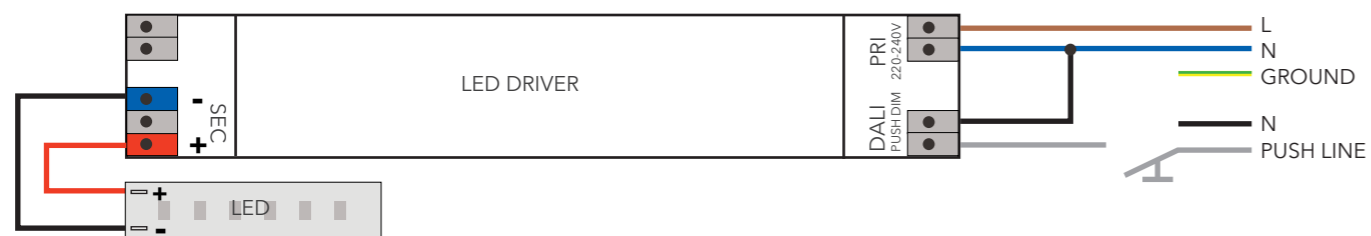

## 4. DIAGRAM 1-10V

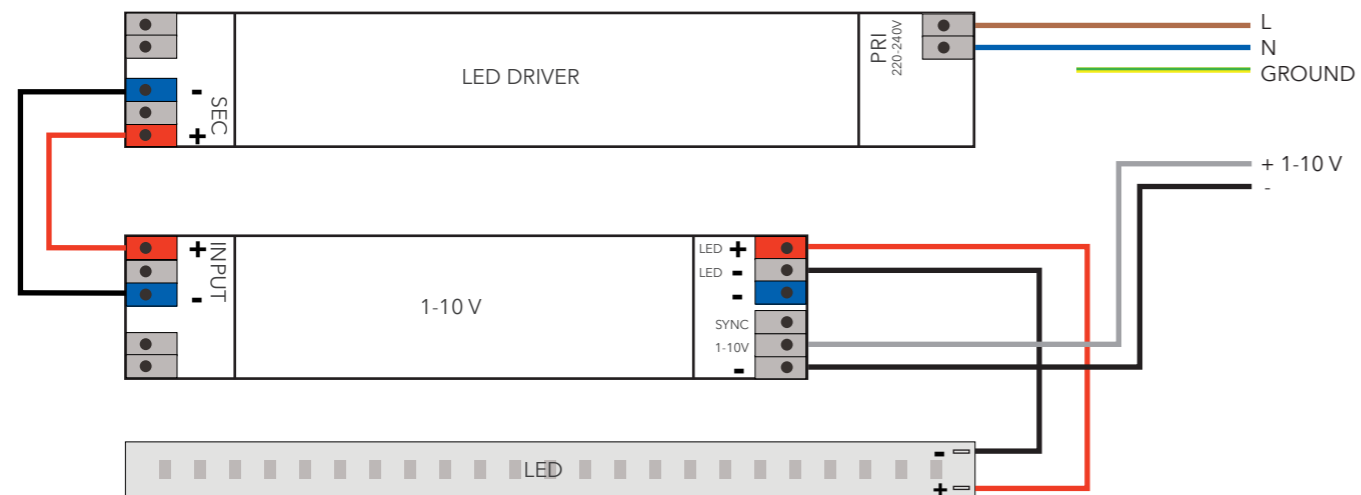

# ANOUR

## I - MODEL CORDLESS DROP CEILING

### Installation manual

Please, read our instructions before installing and using the product. If you have any problems with the electrical installation, contact an electrician. Be sure to turn off the power before you start the installation. In some countries, all electrical installation must be carried out by professional electricians only. For further information, contact the relevant authorities.

Our products are for indoor use only. Check on a regular basis that the cord and other parts are not damaged. In this case, the product must not be used. Save these instructions for future use.

We use LED as a light source for our products. For replacement of LED contact Anour. The product should not be dismantled as it may get damaged. The product should not come into direct contact with water. Trailing edge dimming is not available for our product. We do not supply power cable from outlet to the power supply.

 Our products are marked with the symbol of the crossed out wheelie bin. That means that the product should not be disposed of with other household waste. Our products must be recycled in accordance with local environmental regulations for the disposal of waste. In complying with this you will help to minimize any adverse effect on human and environmental health. If you have any questions please contact Anour. [contact@anour.dk](mailto:contact@anour.dk) (2021)

### PARTS: (INCLUDED IN THE PACKAGE)

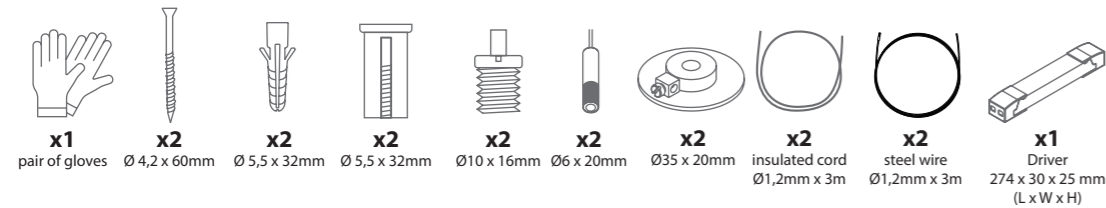

### REQUIRED TOOLS: (NOT INCLUDED)

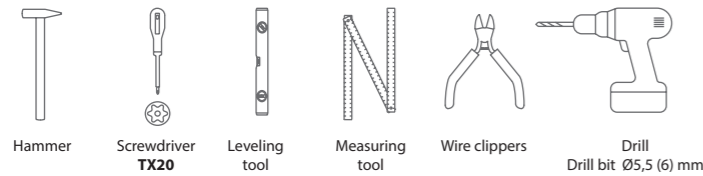

### DIMENSIONS

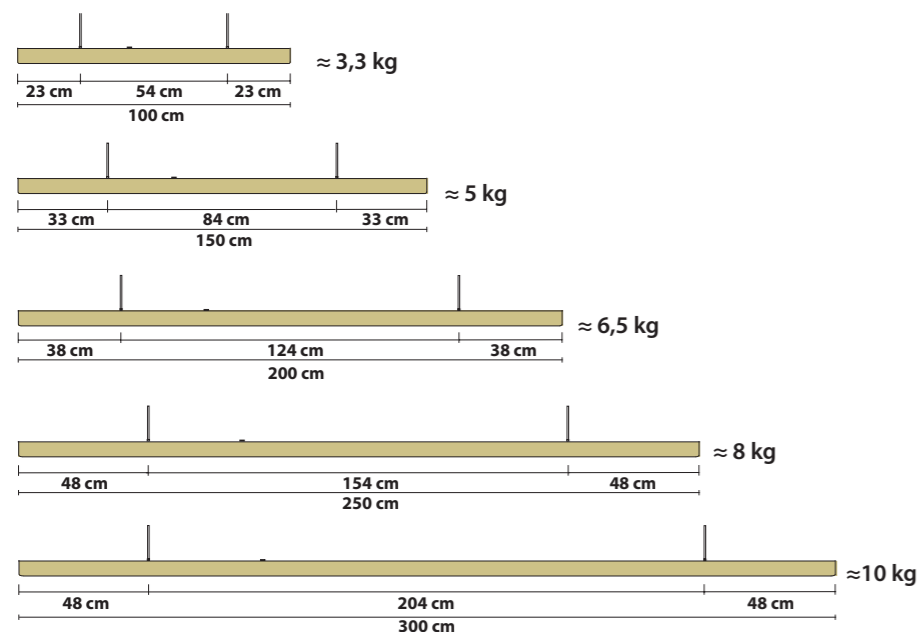

### OPTION: DROP CEILING INSTALLATION

If you wish to receive this installation kit, please mention it when ordering. This is **not** supplied as standard

Please note that this schema won't fit to every type of ceiling installation. Consult an electrician beforehand.

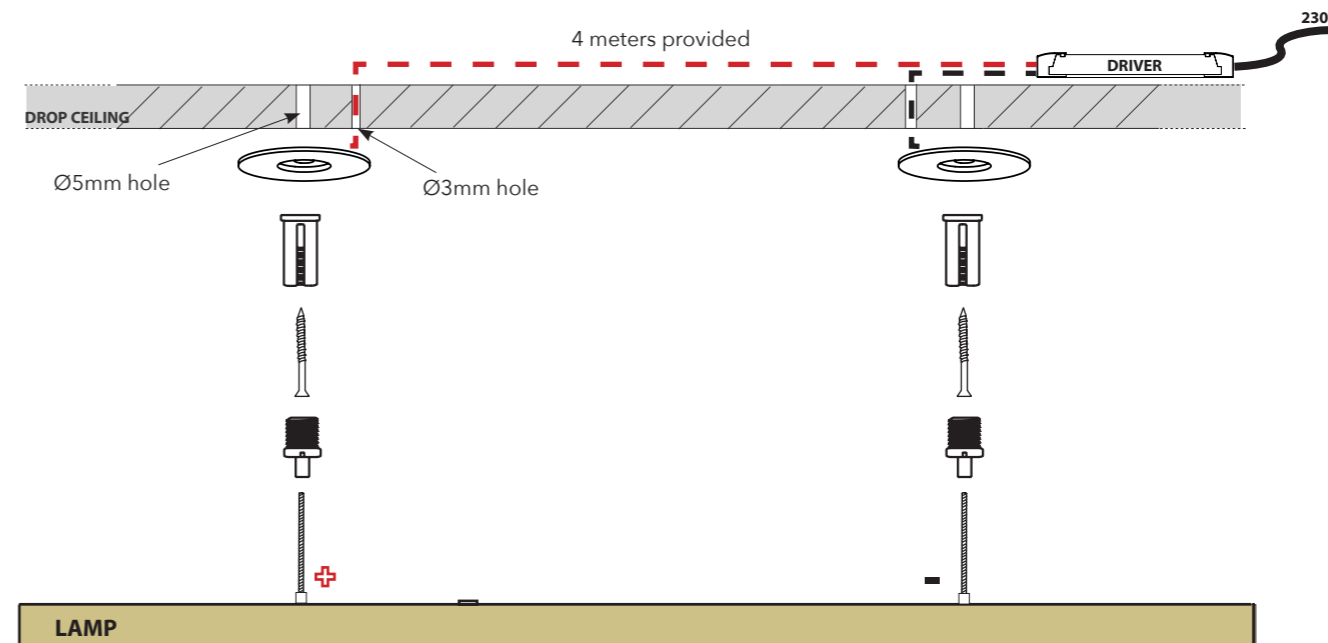
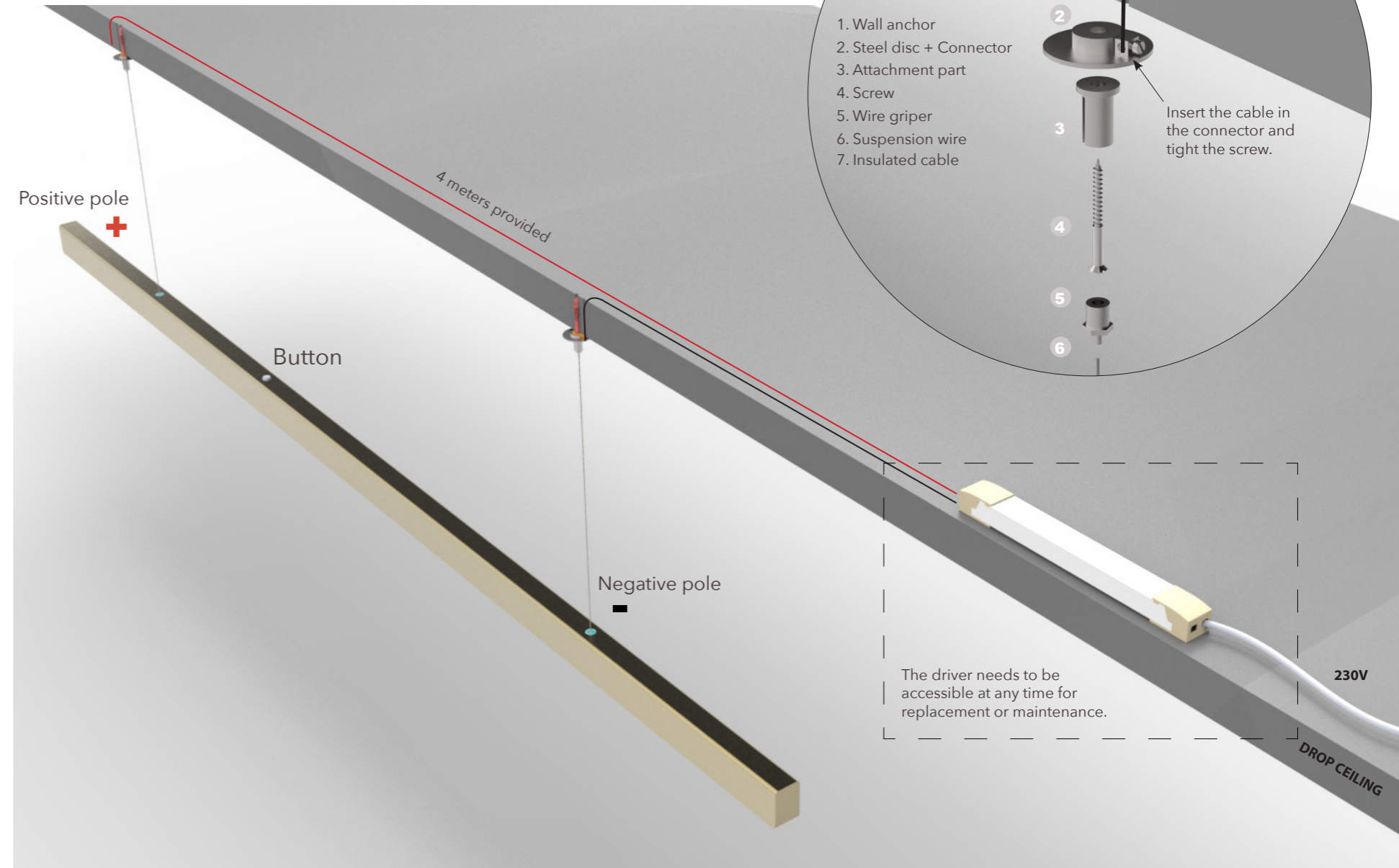

# WIRING INSTALATION MANUAL - luminary length up to **2,5 meter**

**Check your order first, as you cannot combine multiple solutions.**

If you have any problems with the electrical installation, contact an electrician. Be sure to turn off the power before you start the installation. In some countries, all electrical installation must be carried out by professional electricians only. For further information, contact the relevant authorities.

Trailing edge dimming is not available.

We do not supply power cable from outlet to power supply.

## 1. DIAGRAM STANDARD WITH TOUCH DIMMER BUTTON ON THE LAMP

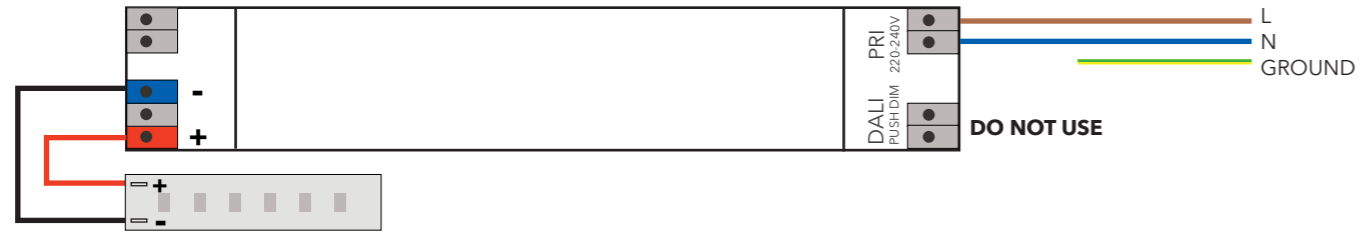

## 2. DIAGRAM DALI

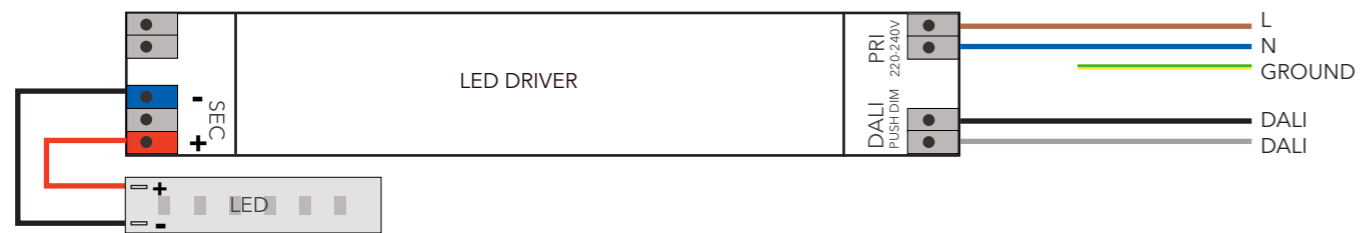

## 3. DIAGRAM PUSH DIM

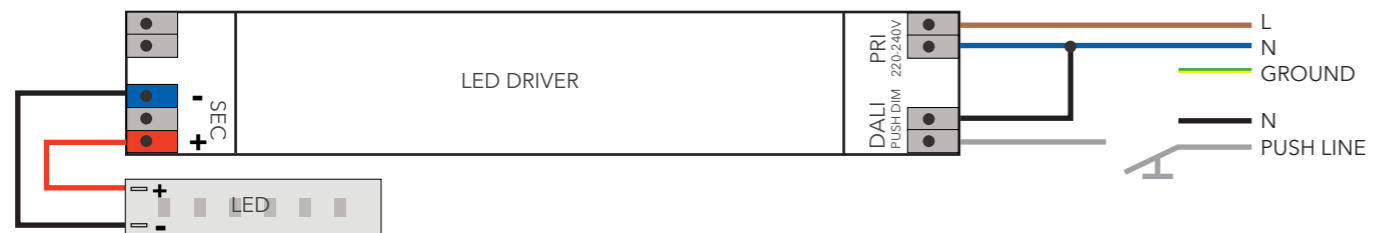

## 4. DIAGRAM 1-10V

