

ANOUR

I - MODEL AURA

Installation manual

Please, read our instructions before installing and using the product.

Unpack the lamp upon receiving it. If you keep the lamp in the original packing for a prolonged period, the lamp surface might be affected.

If you have any problems with the electrical installation, contact an electrician. Be sure to turn off the power before you start the installation. In some countries, all electrical installation must be carried out by professional electricians only. For further information, contact the relevant authorities.

Our products are for indoor use only. Check on a regular basis that the wires and other parts are not damaged. In this case, the product must not be used. Save these instructions for future use.

We use LED as a light source for our products. For replacement of LED contact Anour. The product should not be dismantled as it may get damaged. The product should not come into direct contact with water. We do not supply power cable from outlet to the power supply.

The lamp must be connected to the wall switch. This wall switch should be used on a regular basis to ensure the proper functionality of the lamp and driver longevity.

 Our products are marked with the symbol of the crossed out wheelie bin. That means that the product should not be disposed of with other household waste. Our products must be recycled in accordance with local environmental regulations for the disposal of waste. In complying with this you will help to minimize any adverse effect on human and environmental health. If you have any questions please contact Anour.
contact@anour.dk (February 2024)

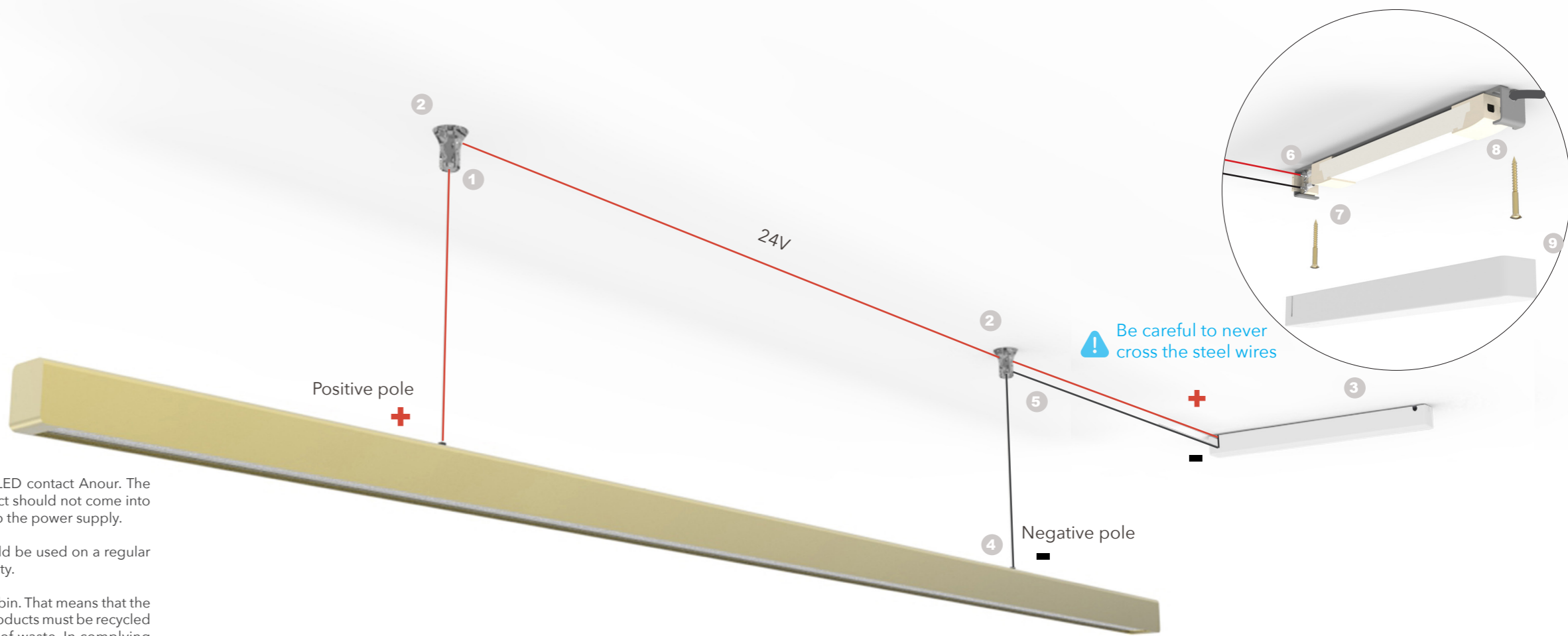

1. Measure distance between the suspension points. (dimensions below) Drill holes and fasten the plastic ceiling components.

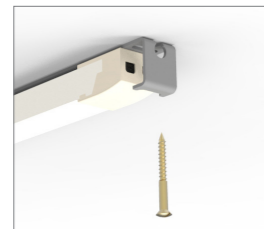

2. Position the driver box (see diagram below), drill holes and fasten it.

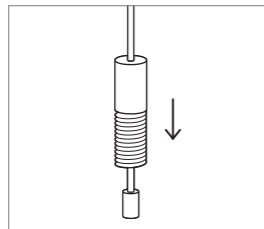

3. Place the wire nipples on the wire.

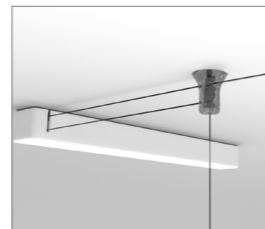

4. Insert the steel wires in the 2 plastic ceiling components. Assure that the wires are aligned.

 Be careful to never cross the steel wires.

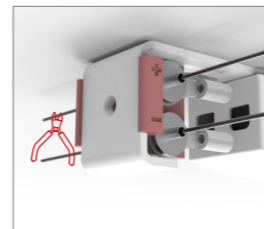

5. Insert the + wire in the + terminal and the - wire in the - terminal.

Cut the wire close to the terminal, do not leave more than 1cm

You can change the position of the poles by repositioning the wire grippers. 

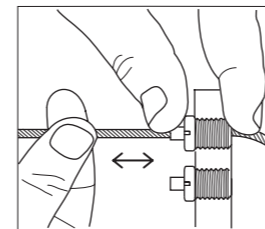

6. Adjust the height of the lamp by pressing the wire gripper and, **cut the excess wire**, as shown.

We recommend to hang the light with a distance of +/- 60cm above a dining table. For kitchen table tops, we recommend +/- 70 - 80cm.

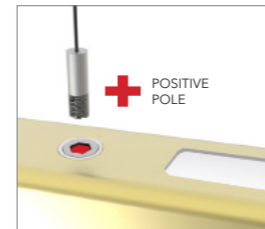

7. Attach the wires to the nipples and tightly fasten the wires to the lamp.

 The positive pole is the suspension point with the red set screw. Take the set screw out before installing the nipple.

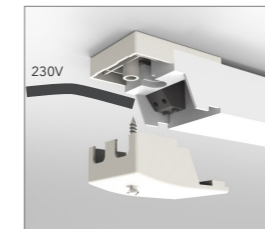

8. Connect the power cable to the (PRI) terminals on the primary side of the power supply and then, fasten the screw of the safety cap.

We do not supply power cable from outlet to power supply.

 Should be performed according to safety regulations.

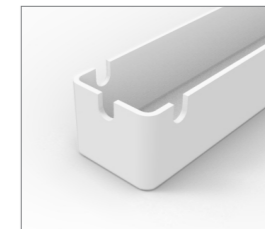

9. Cut out one input for the primary power cable (3 options shown) in the white plastic lid and then attach the lid to the power supply (magnetic closure).

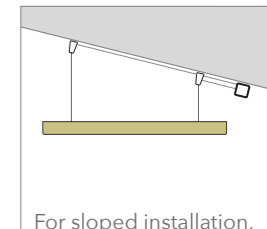

For sloped installation, the driver box must be installed on the same sloped surface like the lamp

DIMENSIONS

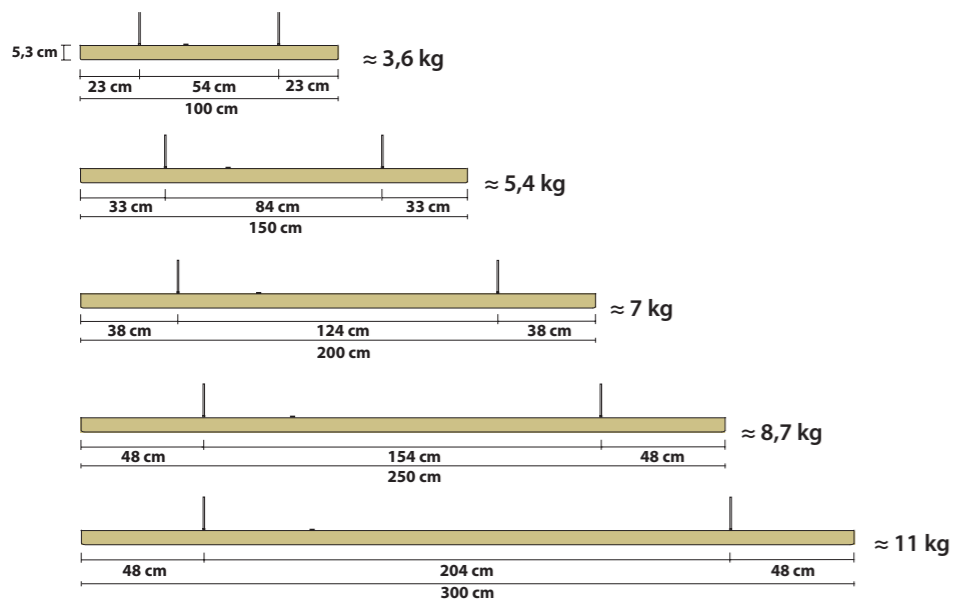

DRIVER BOX POSITION OPTIONS: (TOP VIEW DIAGRAM)

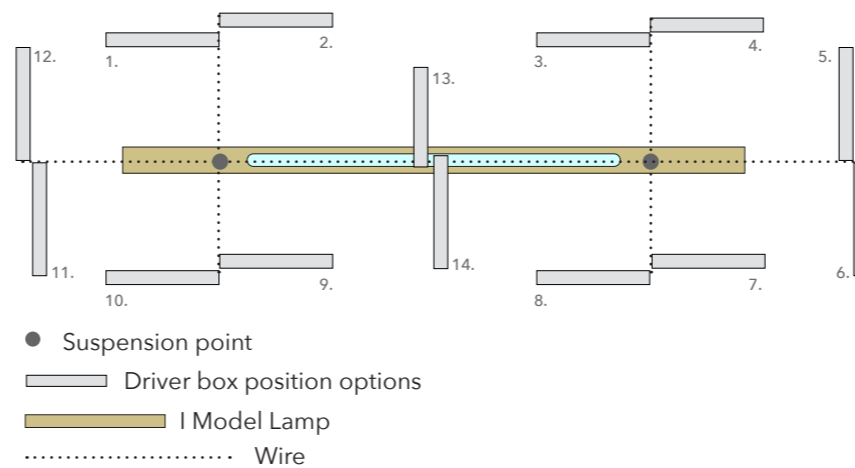

PARTS: (INCLUDED IN THE PACKAGE)

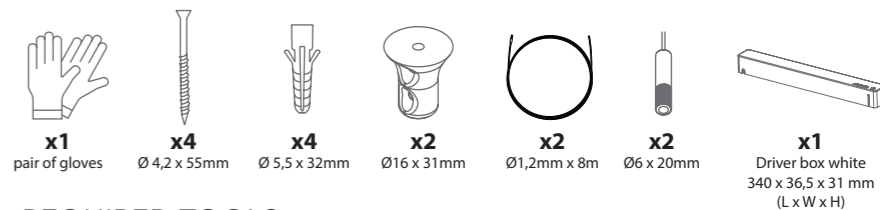

REQUIRED TOOLS: (NOT INCLUDED)

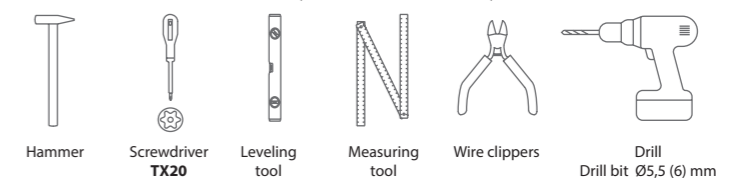

AURA - LUMINARY LENGTH UP TO 1,5 METER

Check your order first, as you cannot combine multiple solutions.

If you have any problems with the electrical installation, contact an electrician. Be sure to turn off the power before you start the installation. In some countries, all electrical installation must be carried out by professional electricians only. For further information, contact the relevant authorities.

We do not supply power cable from outlet to power supply.

For model Aura, we offer external dimming only.

1. DIAGRAM CASAMBI

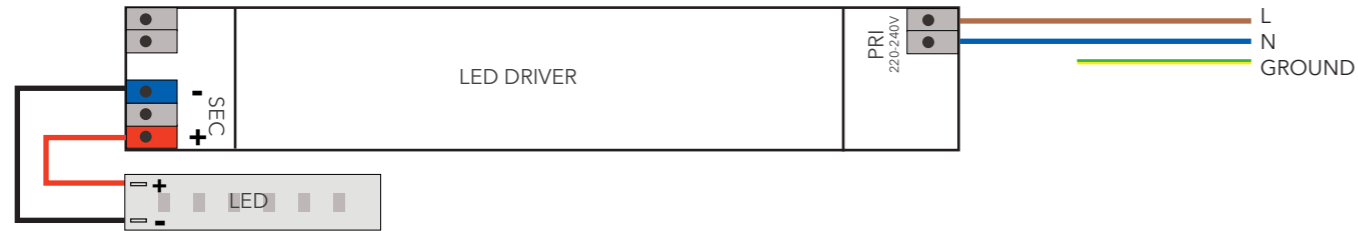

2. DIAGRAM DALI

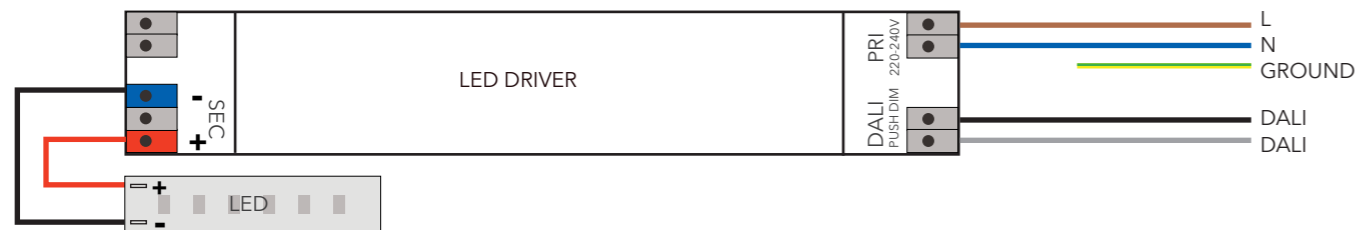

3. DIAGRAM PUSH DIM



4. DIAGRAM 1-10V

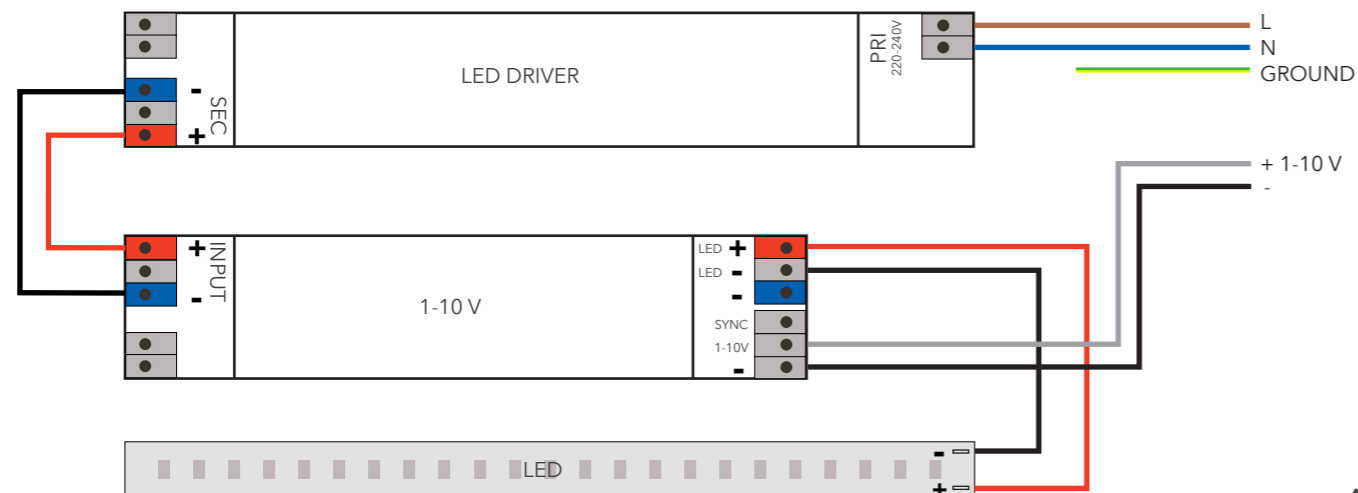

AURA - LUMINARY LENGTH 2,00 - 3,0 METER

1. DIAGRAM CASAMBI

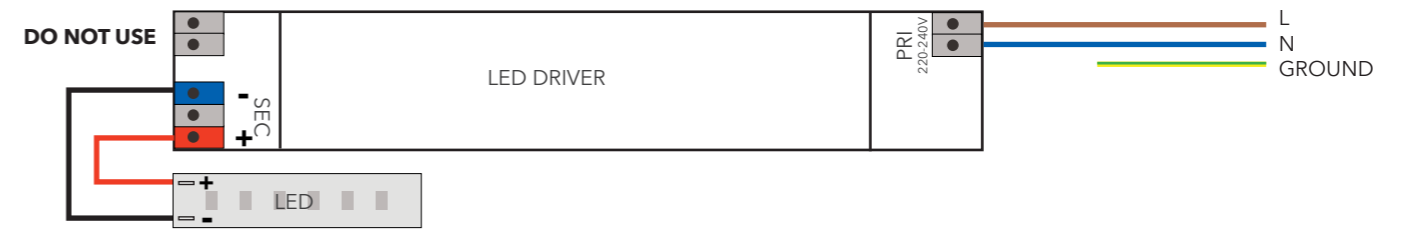

2. DIAGRAM DALI

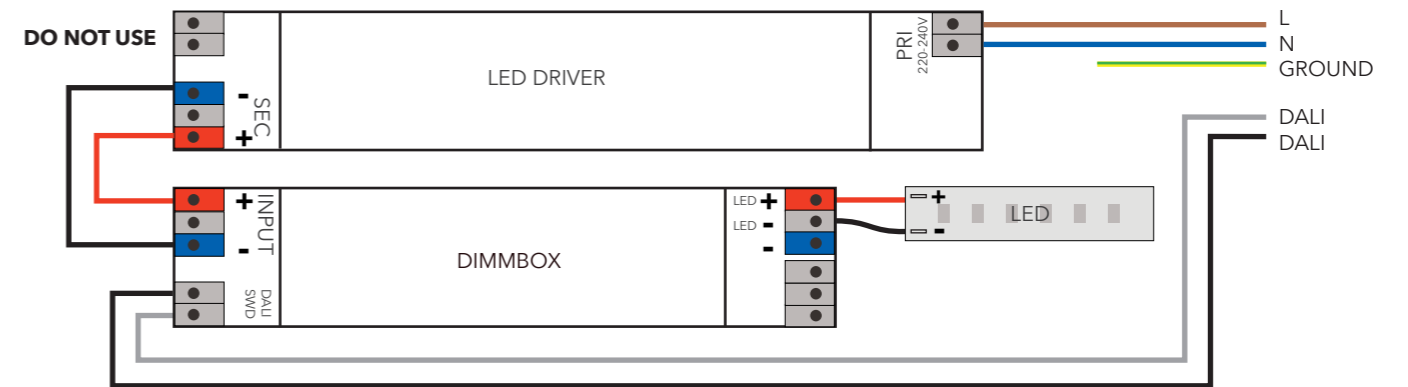

3. DIAGRAM PUSH DIM

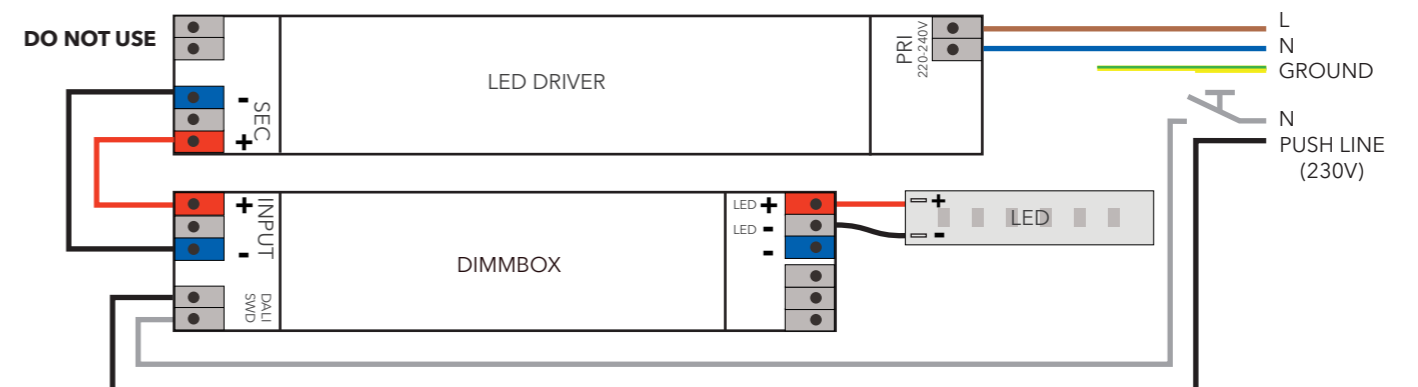

4. DIAGRAM 1-10v

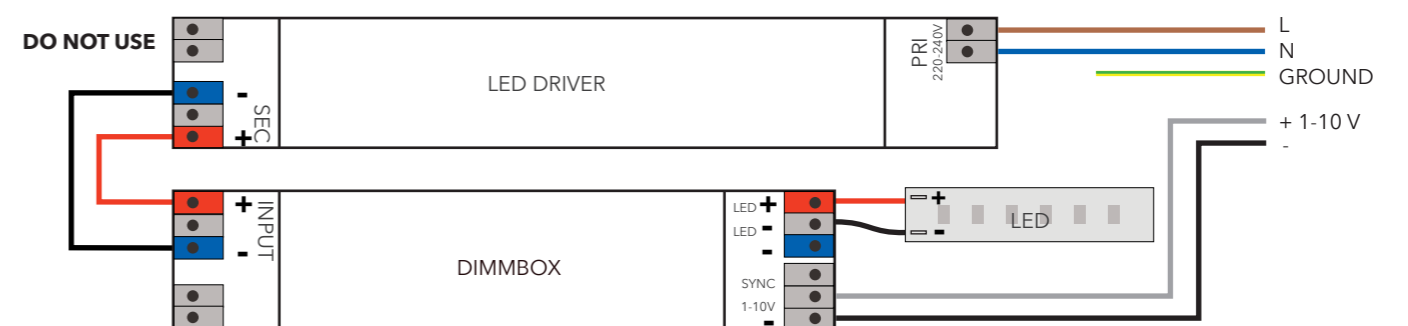

Check your order first, as you cannot combine multiple solutions.

If you have any problems with the electrical installation, contact an electrician. Be sure to turn off the power before you start the installation. In some countries, all electrical installation must be carried out by professional electricians only. For further information, contact the relevant authorities.

DIAGRAM TRIAC WITH EXTERNAL DIMMING

