

ANOUR

DIVAR 2.0
50 cm

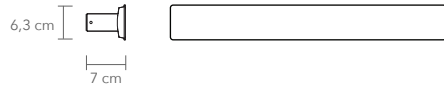
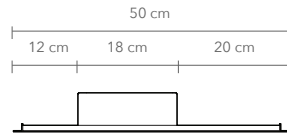

PRODUCT: DIVAR 2.0, 50 cm

LEAD TIME: 8-10 weeks

WEIGHT: 1,7 kg (approximate value)

PACKAGE WEIGHT: 2,0 kg (approximate value)

DIMMER: External dimming Triac as standard
Touch button on the lamp / Dali / Casambi available on request

OPTIONAL CORD: 2m black cord + eu wall plug

CERTIFICATION: CE (230V)

MATERIAL: Steel, Stainless steel, Corten steel, Brass, Copper, Marble

For more technical information, please see the installation manual.

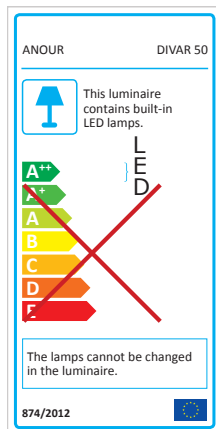

TECHNICAL DETAILS:

240V
Illumination
LED
Wattage: 10 W
Light output: 600 lm
Color temperature: 2700 K
CRI: 93+
LED life hours: 50,000

AVAILABLE MATERIALS AND FINISHES:

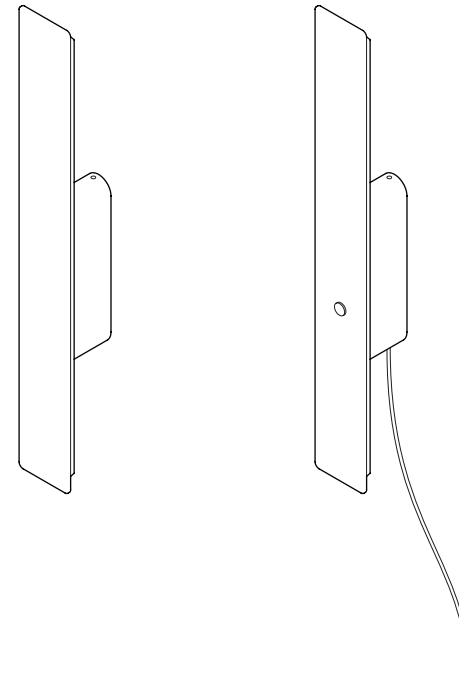
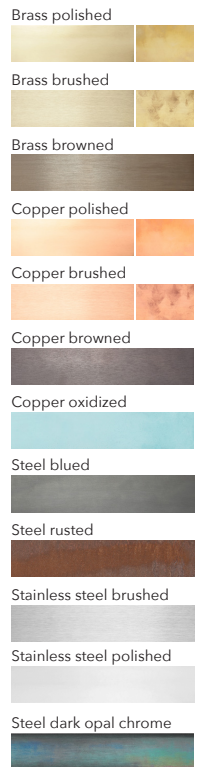

OPTIONAL TOUCH BUTTON ON THE LAMP

OPTIONAL CORD WITH WALL PLUG

ANOUR

DIVAR 2.0
100 cm

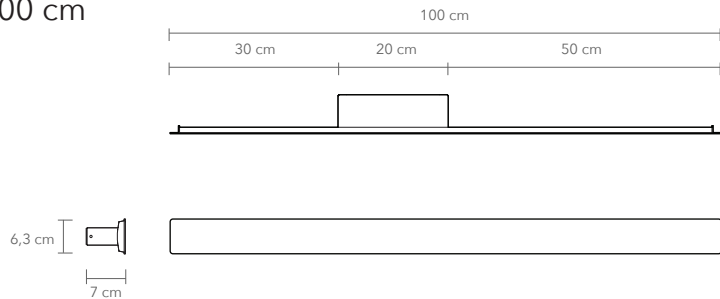

PRODUCT: DIVAR 2.0, 100 cm

LEAD TIME: 8-10 weeks

WEIGHT: 2,5 kg (approximate value)

PACKAGE WEIGHT: 3,4 kg (approximate value)

DIMMER: External dimming Triac as standard
Touch button on the lamp / Dali / Casambi available on request

OPTIONAL CORD: 2m black cord + eu wall plug

CERTIFICATION: CE (230V)

MATERIAL: Steel, Stainless steel, Corten steel, Brass, Copper, Marble

For more technical information, please see the installation manual.

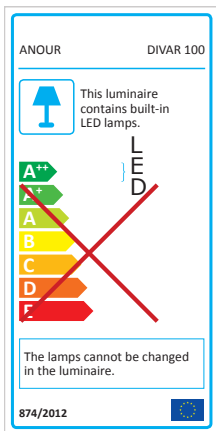

TECHNICAL DETAILS:

240V
Illumination
LED
Wattage: 20 W
Light output: 1345 lm
Color temperature: 2700 K
CRI: 93+
LED life hours: 50,000

AVAILABLE MATERIALS AND FINISHES:

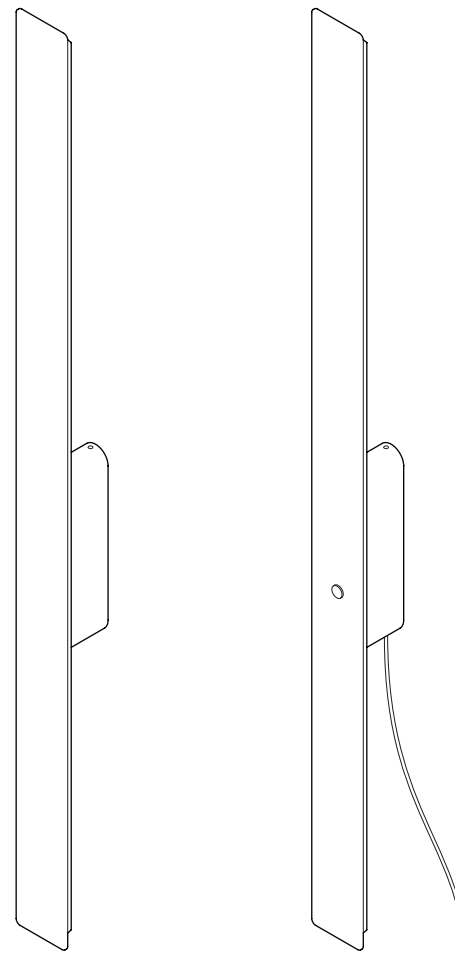
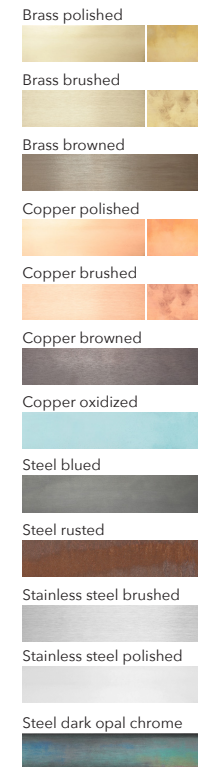

OPTIONAL TOUCH BUTTON ON THE LAMP

OPTIONAL CORD WITH WALL PLUG

ANOUR

DIVAR 2.0
150 cm

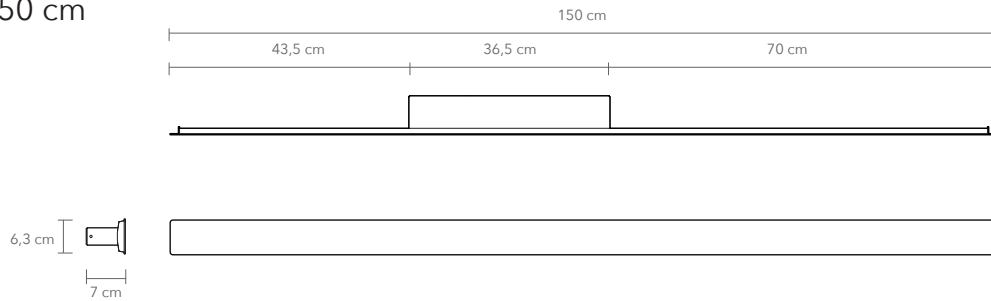

PRODUCT: DIVAR 2.0, 150 cm

LEAD TIME: 8-10 weeks

WEIGHT: 3,7 kg (approximate value)

PACKAGE WEIGHT: 4,9 kg (approximate value)

DIMMER: External dimming Triac as standard
Touch button on the lamp / Dali / Casambi available on request

OPTIONAL CORD: 2m black cord + eu wall plug

CERTIFICATION: CE (230V)

MATERIAL: Steel, Stainless steel, Corten steel, Brass, Copper, Marble

For more technical information, please see the installation manual.

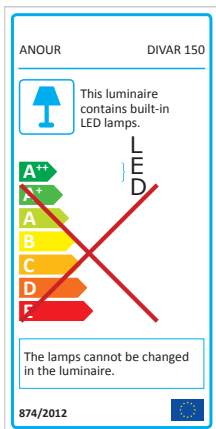

TECHNICAL DETAILS:

240V
Illumination
LED
Wattage: 30 W
Light output: 2050 lm
Color temperature: 2700 K
CRI: 93+
LED life hours: 50,000

AVAILABLE MATERIALS AND FINISHES:

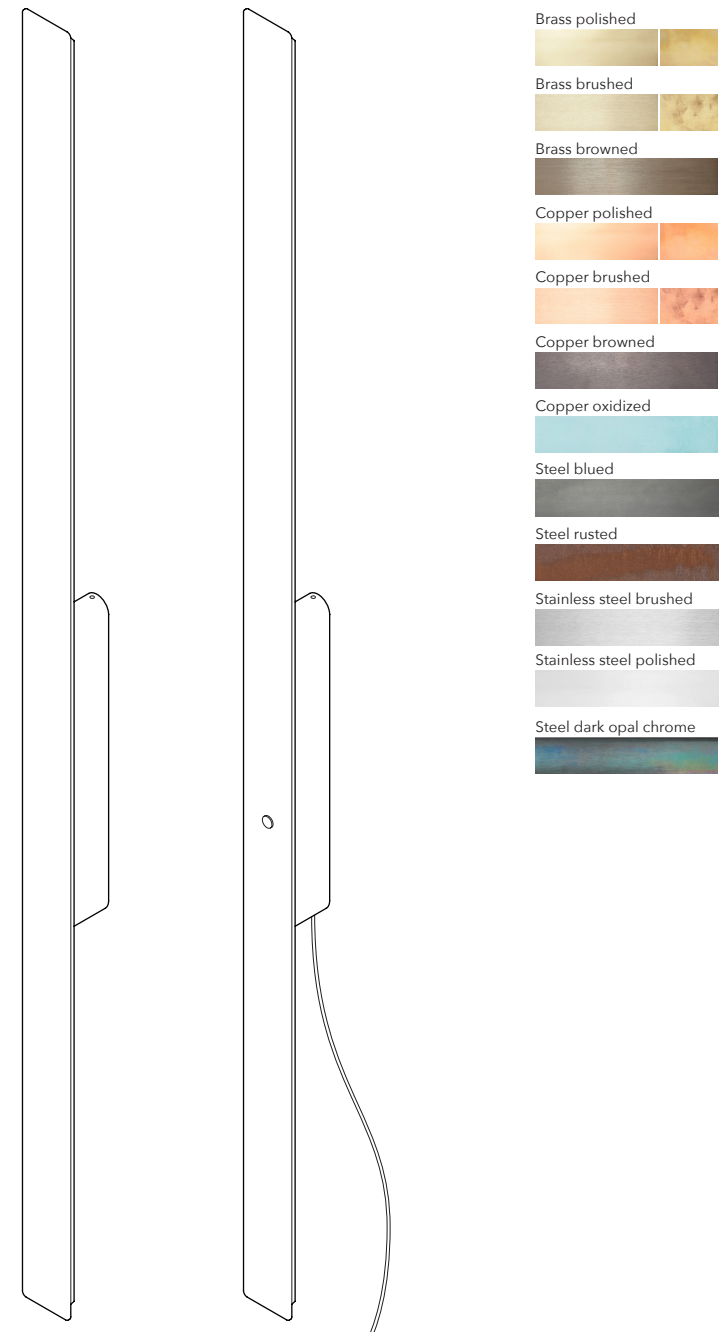

OPTIONAL TOUCH BUTTON ON THE LAMP

OPTIONAL CORD WITH WALL PLUG

ANOUR

DIVAR 2.0
200 cm

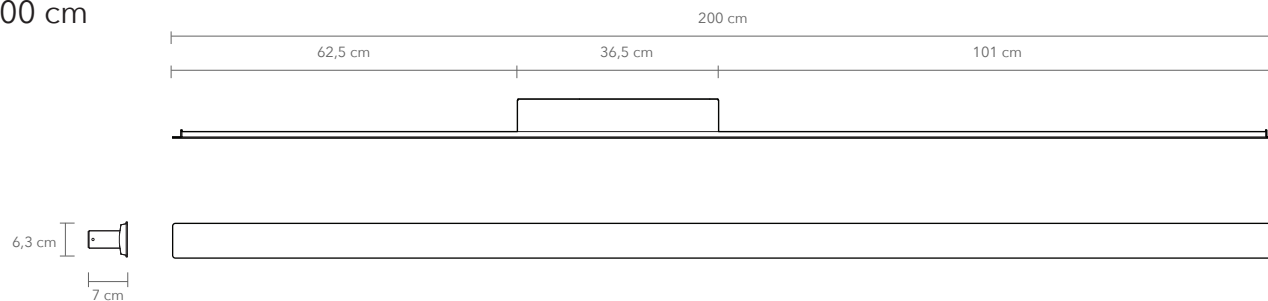

PRODUCT: DIVAR 2.0, 200 cm

LEAD TIME: 8-10 weeks

WEIGHT: 4,6 kg (approximate value)

PACKAGE WEIGHT: 6,1 kg (approximate value)

DIMMER: External dimming Triac as standard
Touch button on the lamp / Dali / Casambi available on request

OPTIONAL CORD: 2m black cord + eu wall plug

CERTIFICATION: CE (230V)

MATERIAL: Steel, Stainless steel, Corten steel, Brass, Copper, Marble

For more technical information, please see the installation manual.

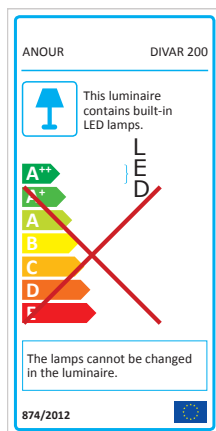

TECHNICAL DETAILS:

240V
Illumination
LED
Wattage: 40 W
Light output: 2760 lm
Color temperature: 2700 K
CRI: 93+
LED life hours: 50,000

AVAILABLE MATERIALS AND FINISHES:

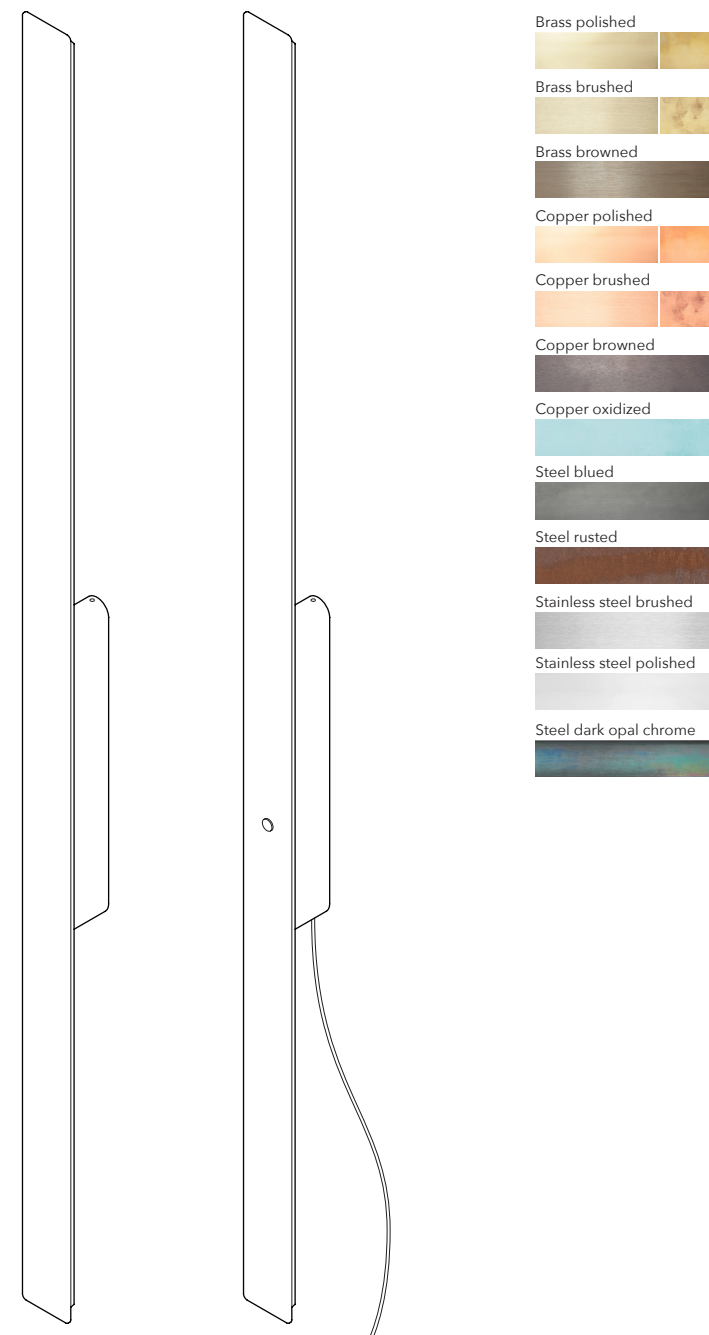

OPTIONAL TOUCH BUTTON ON THE LAMP

OPTIONAL CORD WITH WALL PLUG